



Issue No. : WBHM1608SF-T-110808-A
Date of issue :
Classification : New Changed Revised

PRODUCT SPECIFICATION FOR APPROVAL

Brand : wiwintech

Customer : _____

Customer P/N : _____

Description : Common Mode Noise Filter Array (Multilayer Type)
1.60±0.10mm × 0.80±0.10mm H : 0.40±0.10mm

Part Name : WBHM1608SF4P Series

Date : AUG.08.2011

Term of Validity : AUG.07.2016 from the day of issue

REMARK:		
Customer Approval Feedback		

Prepared by: Product Engineering Service Section Engineering Department		
Approved	Checked	Designed
David Zhao	Sean Lu	Jimmy Sung

[SPECIFICATION]

Common Mode Noise Filter Array (WBHM1608SF4P)

11 - 1

- * All the materials used in this product are registered material under the Law Concerning the Examination and Regulation of Manufacture, etc. of Chemical Substances.
- * This product has not been manufactured with any ozone-depleting chemical controlled under the Montreal Protocol.
- * All the materials used in this product contain no brominated materials of PBBOs or PBBs as the flame-retardant.
- * "The Term of Validity" of Product Specifications for Information Unless otherwise requested (including from customer), the term of validity shall be renewed automatically. Then, information and specifications shall be not issued.

1. SCOPE

This specification covers the Power Inductor to be delivered to.

2. PART NUMBER OF PRODUCTS

This part number of the products in this specification shall be WBHM1608SF4P Series.

3. TEST CONDITIONS

The ambient temperature shall be 5°C to 35°C and the relative humidity 35% to 85%, unless otherwise specified. When the test result is doubtful, the sample in question shall be tested again at 20±2°C, 65±5%RH.

4. APPEARANCE DIMENSIONS AND CONSTRUCTION

Inductors shall be free from distortion, damage, contaminants, whysker and shall be within dimensions specified.

5. ELECTRICAL CHARACTERISTICS

As specified in the electrical characteristics table.

6. RELIABILITY CHARACTERISTICS

As specified in the reliability characteristics table.

7. PACKAGE

The products shall be packed so as not allow absorption damage.

8. OPERATING TEMPERATURE

-40°C~+125°C

9. OTHERS

The customer is requested to store the products at the normal temperature (-5~35°C) and the normal humidity (85%RH max.) in the packages we supplied.

The package shall not be exposed to direct sunlight and harmful gas and care should be taken so as not to cause dew.

No.	Date	Revision	Check
APPROVAL		CHECK	DESIGN
David Zhao		Sean Lu	Jimmy Sung

[SPECIFICATION]

Common Mode Noise Filter Array (WBHM1608SF4P)

11 - 2

■ Features

- 2 Common mode noise filters in one package.
- Reduce the common mode noise and reform the signal wave by high-coupled inductors
- Rigidly layered and sintered structure with high resistance to reflow heat and mounting reliability.
- IEEE1394 data line such as PCs, DVC, TV.
- LVDS data line such as PCs, TV.

RoHS

Halogen

■ Appearance Dimensions and Construction

Unit : m/m

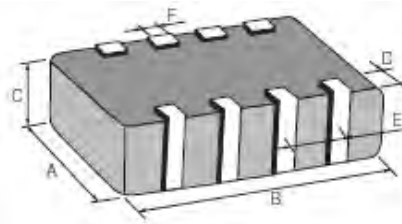
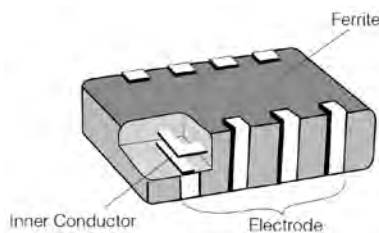

A	0.80±0.10
B	1.60±0.10
C	0.40±0.10
D	0.20±0.10
E	0.40±0.10
F	0.20±0.10

■ Circuit Configuration(No Polarity)

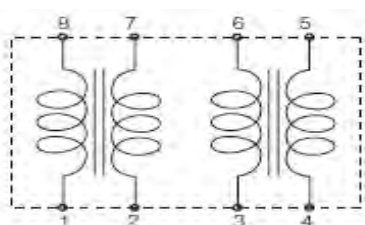
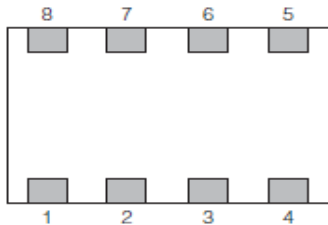

■ Part Number

W	BHM	1608	S	F	4P	900	S
(1)	(2)	(3)	(4)	(5)	(6)	(7)	(8)

(1) Brand Code: W

(2) Product Code : Common Mode Choke

(3) Size Code : L x W mm : 1608 (0603), 1.60±0.10mm × 0.80±0.10mm H : 0.40±0.10mm

(4) S : with magnetic shield

(5) Material Code : F: Fritte

(6) Circuit : 4 Line → 4P

(7) Impedance[Ω](Type at 100 MHz) : the first two digits are significant figure of impedance

value and the third one denotes the number of zero following.

60Ω : 600 , 600Ω : 601 , 1000Ω : 102

(8) Tolerance Code: S : ±25%

[SPECIFICATION]

Common Mode Noise Filter Array (WBHM1608SF4P)

11 - 3

Part No.	Common Mode Impedance (at 100MHz) (Ω)	Differential Mode Impedance (at 100MHz) (Ω) (Max)	DCR (Ω) (max)	Rated Current (mA) (max)	Rated Voltage vdc. (V)
WBHM1608SF4P650S	65 \pm 25%	18	1.80	140	5
WBHM1608SF4P900S	90 \pm 25%	20	2.00	130	5
WBHM2010SF4P201S	200 \pm 25%	22	3.50	100	5

Impedance measurement equipment : HP4291A or Corresponding equipment

■ Characteristics Impedance (Reference)

WBHM1608SF4P650S

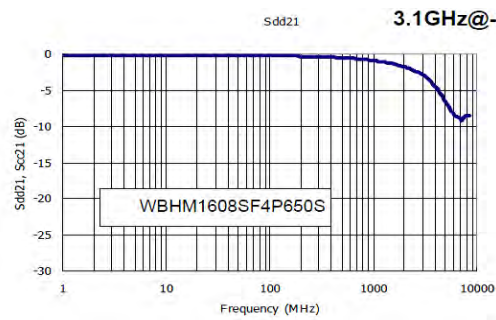
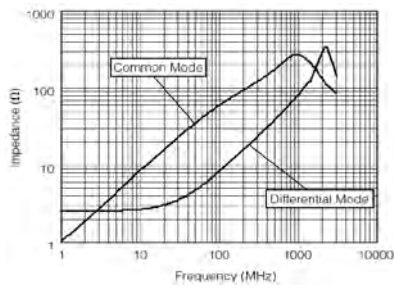

WBHM1608SF4P900S

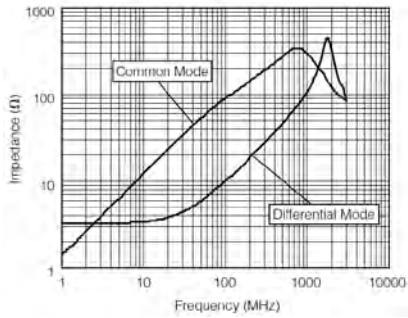

WBHM1608SF4P201S

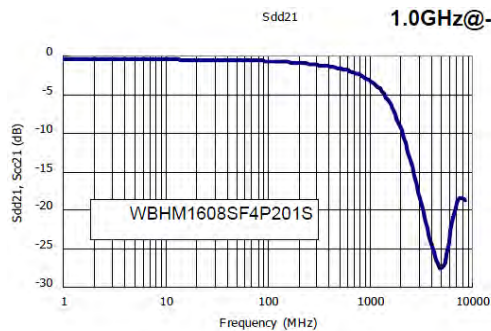
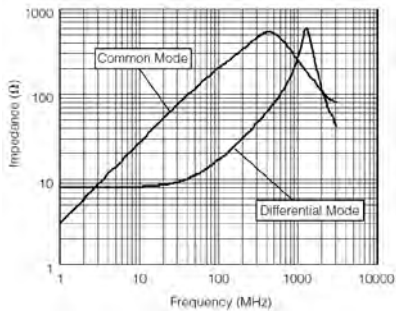

■ Measurement Circuit

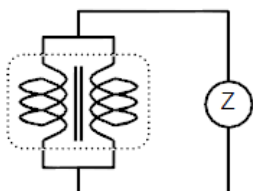

Common Mode

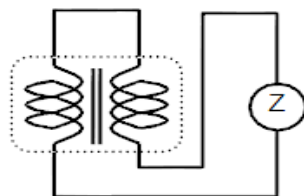

Differential Mode

[SPECIFICATION]

Common Mode Noise Filter Array (WBHM1608SF4P)

11 - 4

ITEM	SPECIFICATION	TEST METHOD/CONDITION
DIELECTRIC STRENGTH	Without damage	100V DC shall be applied for 60s between the terminal and the core
INSULATION RESISTANCE	100MΩ or more	100V DC shall be applied between the terminal and the core
TEMPERATURE CHARACTERISTICS	Must be satisfy electrical characteristics	-40~+85°C Standard: Values at 20°C
HUMIDITY CHARACTERISTICS	*There shall not be case deformation or change in appearance. *Variation of inductance shall be within ±3%. *Must be satisfy electrical characteristics	Inductors shall be stored to 90~95%RH at 60±2°C for 500±8 hours. Measurements shall be made after 1 hour Stabilization at room temperature.
HEAT RESISTANCE		Inductors shall be stored to 85±2°C for 500±8 hours. Measurements shall be made after 1 hour stabillization at room temperature.
THERMAL SHOCK		Inductors shall be stored 100 times to the following temperature cycle. 1. -40°C, 30 minutes 2. +85°C, 30 minutes Measurements shall be made after 1 hour stabillization at room temperature.
LOW TEMPARATURE STRAGE		Inductors shall be stored to -40+2°C for 500±8 hours. Measurements shall be made after 1 hour stabillization at room temperature.
HIGH TEMPERATURE LOAD LIFE		With rated current applied. Indicators shall be stored at 85±2°C for 500±8 hours. Measurements shall be made after 1 hour stabillization at room temperature.
HUMIDITY LOAD LIFE	With rated current applied. Indicators shall be subjected to 90~95%RH at 60±2°C for 500±8 hours. Measurements shall be made after 1 hour stabillization at room temperature.	

[SPECIFICATION]

Common Mode Noise Filter Array (WBHM1608SF4P)

11 - 5

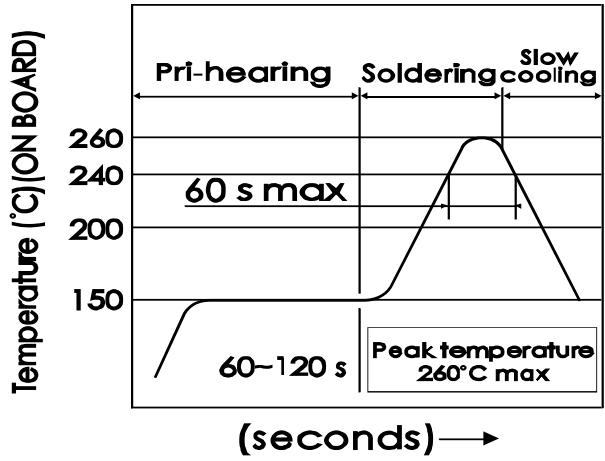
ITEM	SPECIFICATION	TEST METHOD/CONDITION
Resistance To Soldering Heat	<p>*There shall not be case deformation or change in appearance.</p> <p>*Variation of inductance shall be within $\pm 3\%$</p> <p>*Must be satisfy electrical characteristics.</p>	<p>The coil shall be passed through the reflow furnace with the condition shown in profile below for 2 times. And then the coil shall be subjected to standard atmospheric conditions for 1 to 2 hours after which measurement shall be made.</p> <p>For other procedures, refer to IEC Pub. 68-20, Test Tb.</p> <p>A temperature does a temperature on a board.</p> <div style="text-align: center;">  <p>The graph shows a temperature profile for a reflow furnace. The y-axis is labeled 'Temperature (°C) (ON BOARD)' with values 150, 200, 240, and 260. The x-axis is labeled '(seconds) →'. The profile is divided into three phases: 'Pri-heating' (ramp up from 150°C to 200°C, labeled '60~120 s'), 'Soldering' (ramp up to a peak of 260°C, labeled '60 s max'), and 'Slow cooling' (ramp down from 260°C to 150°C). A box in the graph states 'Peak temperature 260°C max'.</p> </div>
Vibration	<p>*There shall not be case deformation or change in appearance.</p> <p>*Variation of inductance shall be within $\pm 3\%$</p> <p>*Must be satisfy electrical characteristics.</p>	<p>Only endurance conditioning by a frequency sweep shall be made. The entire frequency range, from 10 to 55Hz and return to 10Hz, shall be traversed in 1 minute.</p> <p>Amplitude (total excursion) : 1.5mm</p> <p>This motion shall be applied for a period of 2 hours in each of 3 mutually perpendicular directions (a total of 6 hours).</p>
Shock		<p>Pulse shape : Half sine</p> <p>Peak acceleration : 981m/s² (100G)</p> <p>Duration of the pulse : 6ms</p> <p>Three successive shocks shall be applied in both directions of 3 mutually perpendicular axis (a total of 6 hours).</p>
Terminal Pull Strength	<p>There shall not be case deformation or change in appearance.</p> <p>There shall be no evidence of intermittent contact or open circuiting.</p>	<p>A 4.9N load shall be applied to both terminals in the horizontal direction for 1±0.05 minutes.</p>
Resistance To Solvents	<p>There shall not be case deformation or change in appearance.</p>	<p>Inductors shall be stored to ISOPROPYL-ALCOHOL for 10 minutes respectively.</p>

[SPECIFICATION]

Common Mode Noise Filter Array (WBHM1608SF4P)

11 - 6

■ Packing

• Reel size

Unit : m/m

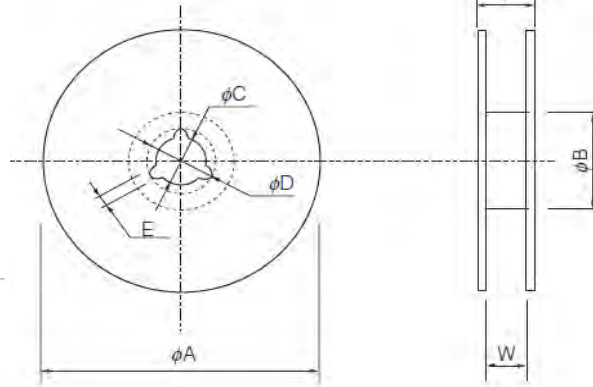
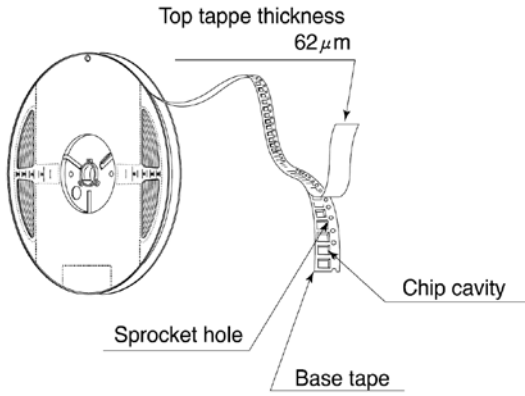

ϕA	180.0 \pm 3.0
ϕB	60.0 \pm 1.0
ϕC	13.0 \pm 0.5
ϕD	21.0 \pm 0.8
E	2.0 \pm 0.5
T	11.4 \pm 1.5
W	9.0 \pm 0.3

• Taping Dimensions

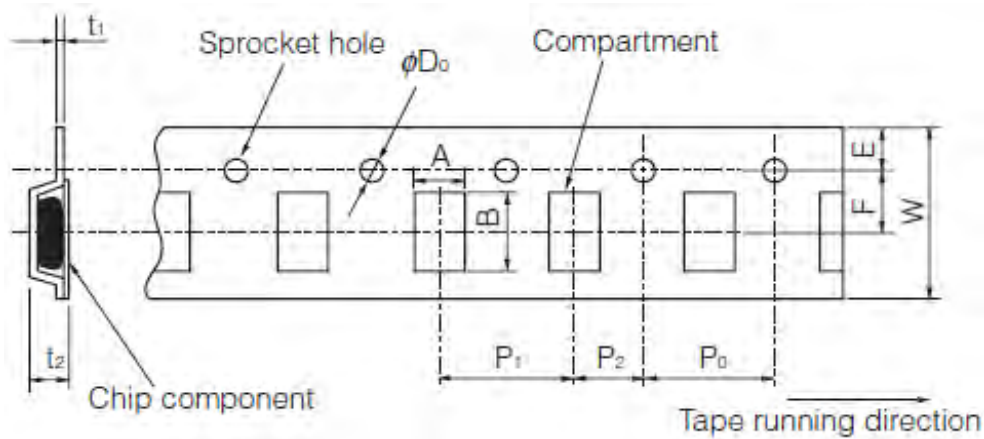

Unit : m/m

A	B	W	F	E	P_1	P_2	P_0
1.0 \pm 0.1	1.8 \pm 0.1	8.0 \pm 0.2	3.5 \pm 0.1	1.75 \pm 0.10	4.0 \pm 0.1	2.0 \pm 0.1	4.0 \pm 0.1
ϕD_0	t_1	t_2					
1.5+0.1/-0	0.25 \pm 0.05	0.80 \pm 0.05					

Reel	
Q'ty(Pcs)	Size m/m
5,000	180 ϕ

[SPECIFICATION]

Common Mode Noise Filter Array (WBHM1608SF4P)

11 - 7

■ Tearing Off Force

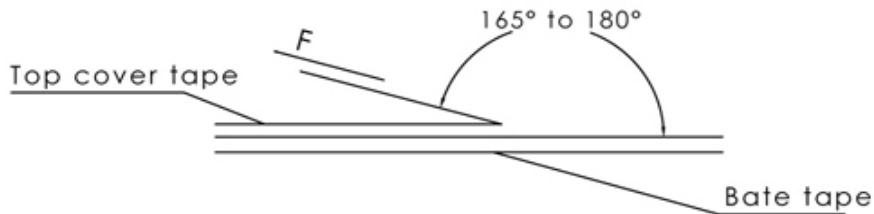

The force for tearing off cover tape is 15 to 60 grams in the arrow direction under the following conditions.

Room Temp.	Room Humidity	Room atm	Tearing Speed
(°C)	(%)	(hPa)	mm/min
5~35	45~85	860~1060	300

Application Notice

• Storage Conditions

To maintain the solderability of terminal electrodes:

1. Temperature and humidity conditions: Less than 40°C and 70% RH.
2. Recommended products should be used within 6 months from the time of delivery.
3. The packaging material should be kept where no chlorine or sulfur exists in the air.

• Transportation

1. Products should be handled with care to avoid damage or contamination from perspiration and skin oils.
2. The use of tweezers or vacuum pick up is strongly recommended for individual components.
3. Bulk handling should ensure that abrasion and mechanical shock are minimized.

[SPECIFICATION]

Common Mode Noise Filter (WBHM1608SF4P)

11 - 8

1-1 Common Mode Impedance

Measured by using Agilent E4991A RF Impedance Analyzer.

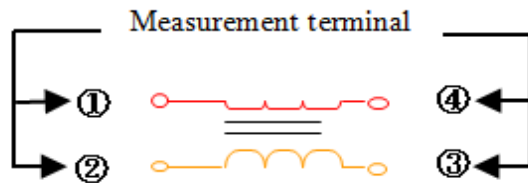

1-2 DC Resistance

Measured by using Chroma 16502 mill ohm meter.

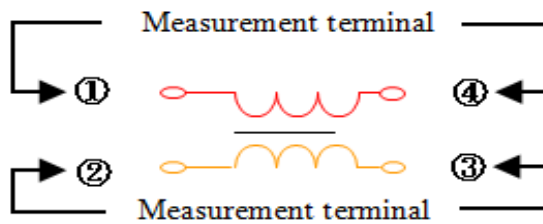

1-3 Insulation Resistance

Measured by using Chroma 19073

Measurement voltage : 50v , Measurement time : 60 sec.

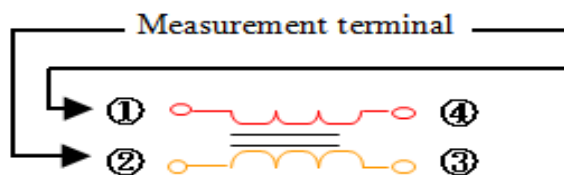

1-4 Withstanding Voltage

Measured by using Chroma 19073

Measurement voltage : DC : 125V , Measurement time : 2 sec.

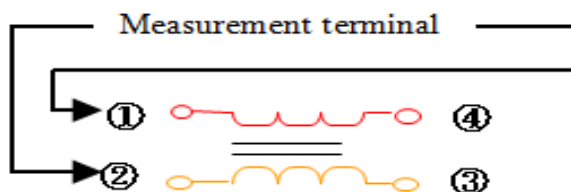

[SPECIFICATION]

Common Mode Noise Filter (WBHM1608SF4P)

11 - 9

ITEM

CONTENTS

Reflow Soldering Profile

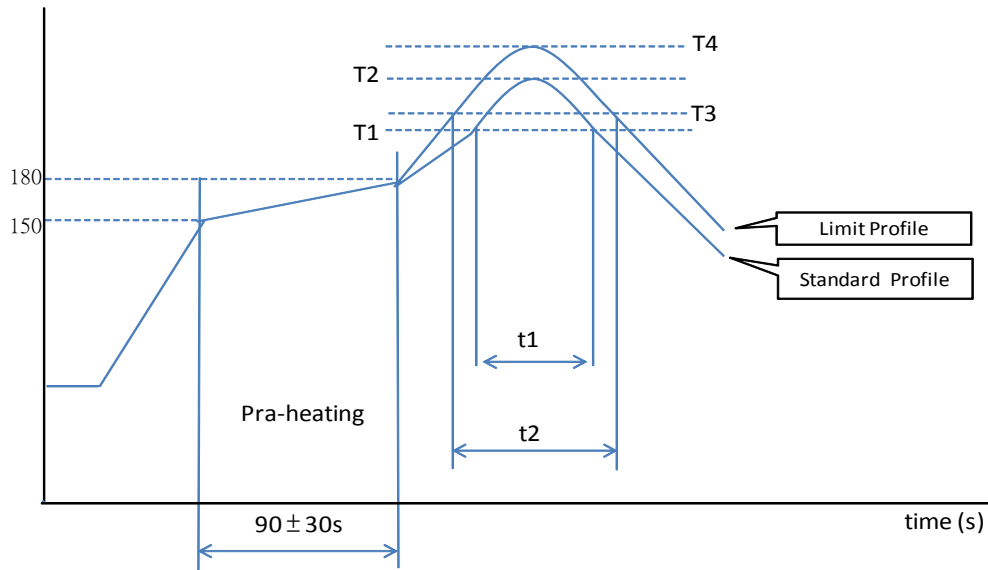

Standard Profile				Limit Profile			
Heating		Peak temperature (T2)	Cycle of reflow	Heating		Peak temperature (T4)	Cycle of reflow
Temp.(T1)	Temp.(t1)			Temp.(T3)	Temp.(t2)		
220°C	30 to 60s	245±3°C	2 times max.	230°C	60s max.	260°C/10s	2 times max.
220°C	30 to 60s	245±3°C	2 times max.	230°C	60s max.	260°C/10s	1 times

The following conditions must be strictly followed when using a soldering iron.

Pre-heating	150°C, 1min
Tip temperature	350°C max.
Soldering iron output	80W max.
Tip diameter	φ3mm max.
Soldering time	3(+1,-0)s
Times	2 times

Note1 : The measurement shall be made after the samples are left in normal temperature and normal humidity for 1 hour in both cases.

Note2 : Do not directly touch the products with the tip of soldering iron in order to prevent the crack on the products due to the thermal shock.

[SPECIFICATION]

Common Mode Noise Filter (WBHM1608SF4P)

11 - 10

ITEM	CONTENTS
Resoldering With a Soldering Iron	<p>The temperature of the soldering iron should be 390°C or less, 5seconds.</p> <p>And resoldering with a soldering iron should be limited to 1time, and after that should be cooling these.</p> <p>Do not touch the resist of grip inductor with the tip of the soldering iron.</p>

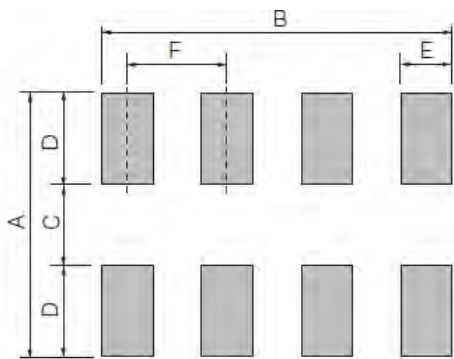
Recommended Land Dimintions	<div style="text-align: center;">  </div> <p style="text-align: right;">Unit : m/m</p> <table border="1" style="margin-left: auto; margin-right: auto; border-collapse: collapse; text-align: center;"> <thead> <tr> <th>A</th> <th>B</th> <th>C</th> <th>D</th> <th>E</th> <th>F</th> </tr> </thead> <tbody> <tr> <td>1.40</td> <td>1.40</td> <td>0.40</td> <td>0.50</td> <td>0.20</td> <td>0.40</td> </tr> </tbody> </table>	A	B	C	D	E	F	1.40	1.40	0.40	0.50	0.20	0.40
A	B	C	D	E	F								
1.40	1.40	0.40	0.50	0.20	0.40								
	<p>1. When this products are mounted on a PCB, the amount of solder used (size of fillet) can directly affect this product performance.</p> <p>2. The amount of solder applied can affect the ability of products to withstand mechanical stresses which may lead to breaking or cracking.</p> <p>Therefore, when designing land-patterns it is necessary to consider the appropriate size and configuration of the solder pads which in turn determines the amount of solder necessary to form the fillets.</p> <p>● Pattern Configurations :</p> <p>1. After this products have been mounted on the PC boards, products can be subjected to mechanical stresses in subsequent manufacturing processes. For this reason, planning pattern configurations and the position of SMD inductors should be carefully performed to minimize stress.</p> <p>2. Board separation should not be done manually, but by using the appropriate devices.</p> <p>● Considerations for Automatic Chip-Mounting</p> <p>Excessive impact load should not be imposed on the inductors when mounting onto the PC boards.</p>												

[SPECIFICATION]

Common Mode Noise Filter (WBHM1608SF4P)

11 - 11

ITEM	CONTENTS
Reflow Soldering	<p>11. Notice for use</p> <p>1. This specification shows the quality and performance of a unit component. Before adoption, be sure to evaluate and verify the product mounting it in your product.</p> <p>2. Precautions on the use of this products.</p> <p>1). Do not apply current in excess of the rated value because this product may be high temperature.</p> <p>2). Always wear static control bands to protect against ESD.</p> <p>3). Keep this products away from all magnets and magnetic object.</p> <p>3. In traffic transportation equipment (trains, cars, traffic signal equipment, etc.), medical equipment, aerospace equipment, electric heating appliances, combustion and gas equipment, disaster and crime preventive equipment, etc. in cases where it is forecast that the failure of this product gives serious damage to the human life and others, use fail-safe design and ensure safety by studying the following items.</p> <p>1). Ensure safety as the system by setting protective circuit and protective equipment.</p> <p>2). Ensure safety as the system by setting such redundant circuit as do not cause danger by a signal failure.</p> <p>4. The products are intended for use in general standard applications for general electronic equipment (AV products, household electric appliances, office equipment, information and communication equipment, etc.) ; hence, they do not take the use under the following special environments into consideration. Accordingly, the use in the following special environments, and such environmental conditions may affect the performance of the products; prior to use, verify the performance, reliability, etc. thoroughly.</p> <p>1). Use in liquids such as water, oil, chemical, and organic solvent</p> <p>2). Where the product is close to a heating component, and where an inflammable such as a polyvinyl chloride wire is arranged close to the product.</p> <p>3). Use in environment with large static electricity and strong electromagnetic waves.</p> <p>4). Where water or water-soluble detergent is used in cleaning free soldering or in flux cleaning after soldering (Pay particular attention to soluble flux)</p> <p>5). Storage in places outside the temperature range of -5 to 40°C and humidity range of 40 to 60%RH</p> <p>6). Use or storage in places exposed to open-air, dusty atmosphere, and direct sunlight</p> <p>7). Use or storage in places full of corrosive gases such as sea breeze, Cl₂, H₂S, NH₃, SO₂, and No_x</p> <p>8). Use or storage in such a place where the product is wetted due to dew condensation.</p> <p>9). Where the product is sealed or coated with resin, etc.</p> <p>10). Storage over six months after our delivery (This item also applies to the case where the storage method specified in item 5) to 8) has been followed.)</p> <p>5. In case that there are any doubt about safety problems, please inform us early and be sure to evaluate and verify the product mounting it in your product before adoption.</p>
Regulation	<p>1. This product has not been manufactured with any ozone depleting chemical controlled under the Montreal Protocol.</p> <p>2. All materials used in this product are existing chemical substances recognized under "laws on examination of chemical substances and regulations of manufacturing and others."</p> <p>3. All materials used in this products contain no brominated materials of PBB0s or PBBs as the flame-retardant.</p> <p>4. Please contact us to obtain a notice as to whether this product has passed inspection under review criteria primarily based on Foreign Exchange and Foreign Trade Control law and appended table in the Export Control law.</p> <p>5. This product complies with the RoHS Directive (Restriction of the use of certain Hazardous Substances in electrical and electronic equipment (DIRECTIVE 2002/95/EC)).</p>